

INSTRUCTIONS D'INSTALLATION ENCASTRE DE PLAFOND

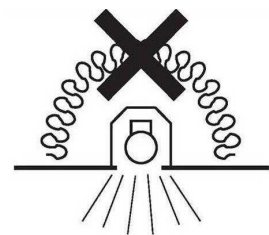

960°C

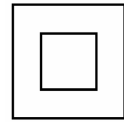

50/60Hz

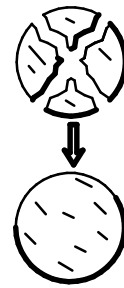
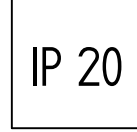

NE PAS COUVRIR DE
MATERIAU ISOLANT

UTILISATION INTERIEURE SEULEMENT

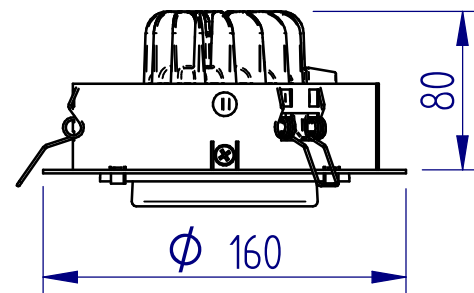
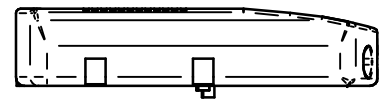

H15A74 / H15B15
H15C65 / A60500
H16C29 / h17d47
H17C45/H17C46
A60504/H17D78
H17E05/H17E06

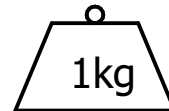

**Encastre A60504 DALI: Nombre de luminaires pouvant être
repiqués directement sur l'alimentation = 13**

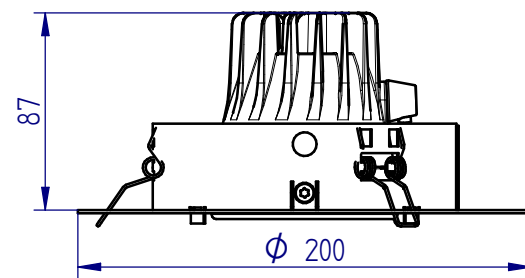
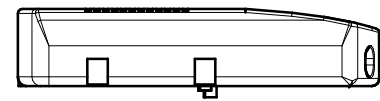

H17D26

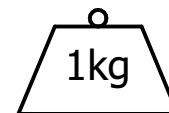

H15A61 / H15B19
H15B42 / A60501

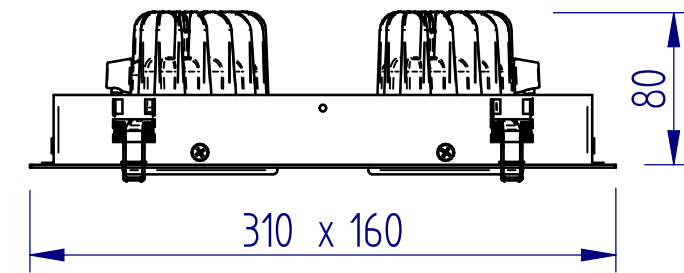
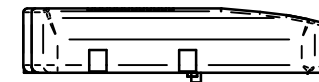
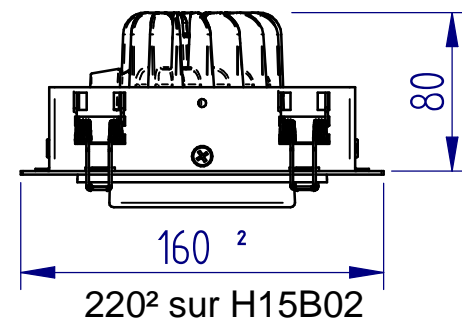
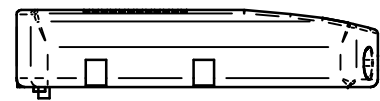
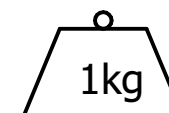
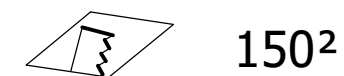

H15A81 / H15B20
H15B43 / H15C66
A60502 / H17C65

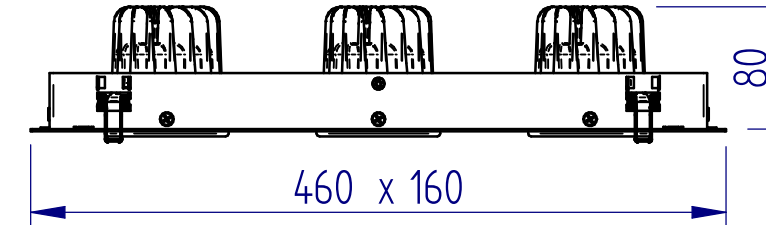
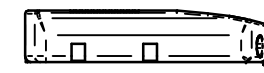
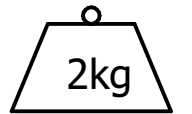

H15B38 / H15B44
A60503

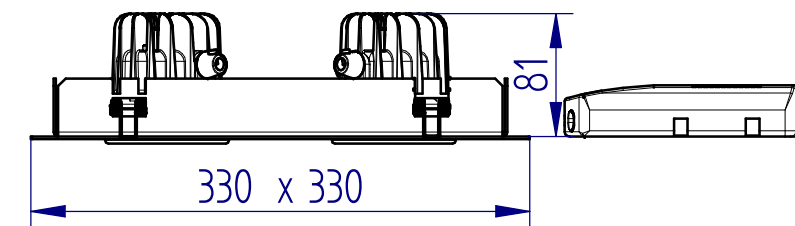
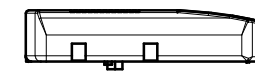
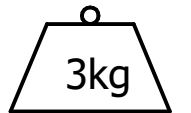

H15C13

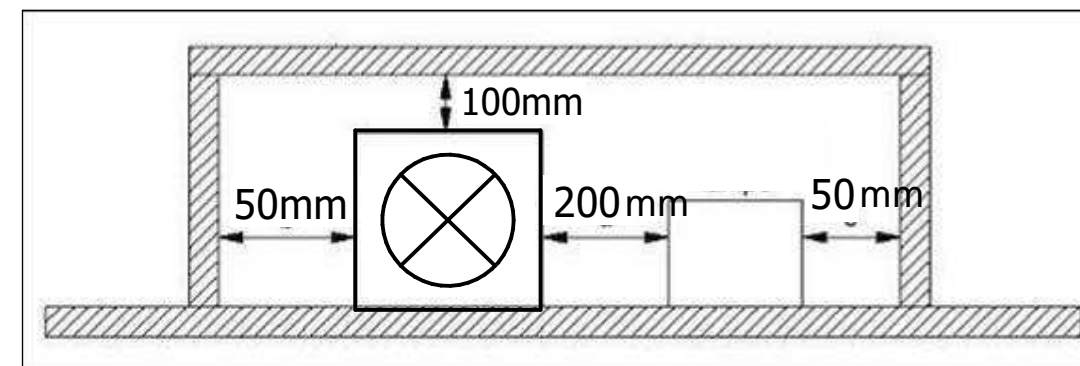
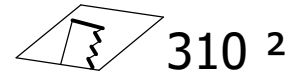

Si le câble extérieur souple ou le cordon de ce luminaire est endommagé, il doit être remplacé par un câble ou un cordon spécial provenant exclusivement du fabricant ou de son service de maintenance.

La source lumineuse contenue dans ce luminaire ne doit être remplacée que par le fabricant ou son agent de maintenance ou une personne de qualification équivalente